

*The eGaN[®] Technology
Journey Continues*

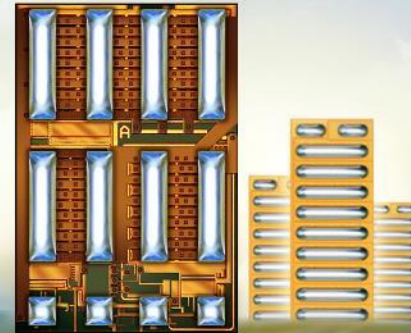

EPC2218 Thermal Model

EPC2218 FEA thermal simulations



- The thermal model applies to EPC2218.
- A power dissipation of 1 W in the device active area is assumed.
- Finite element analysis (FEA) thermal simulations
 - $R_{\theta_{JB}}$ and $R_{\theta_{JC}}$ are obtained by stationary simulations.
 - $Z_{\theta_{JB}}$ and $Z_{\theta_{JC}}$ are obtained by transient simulations.
- R-C thermal model is generated.

EPC2218 geometry in simulation

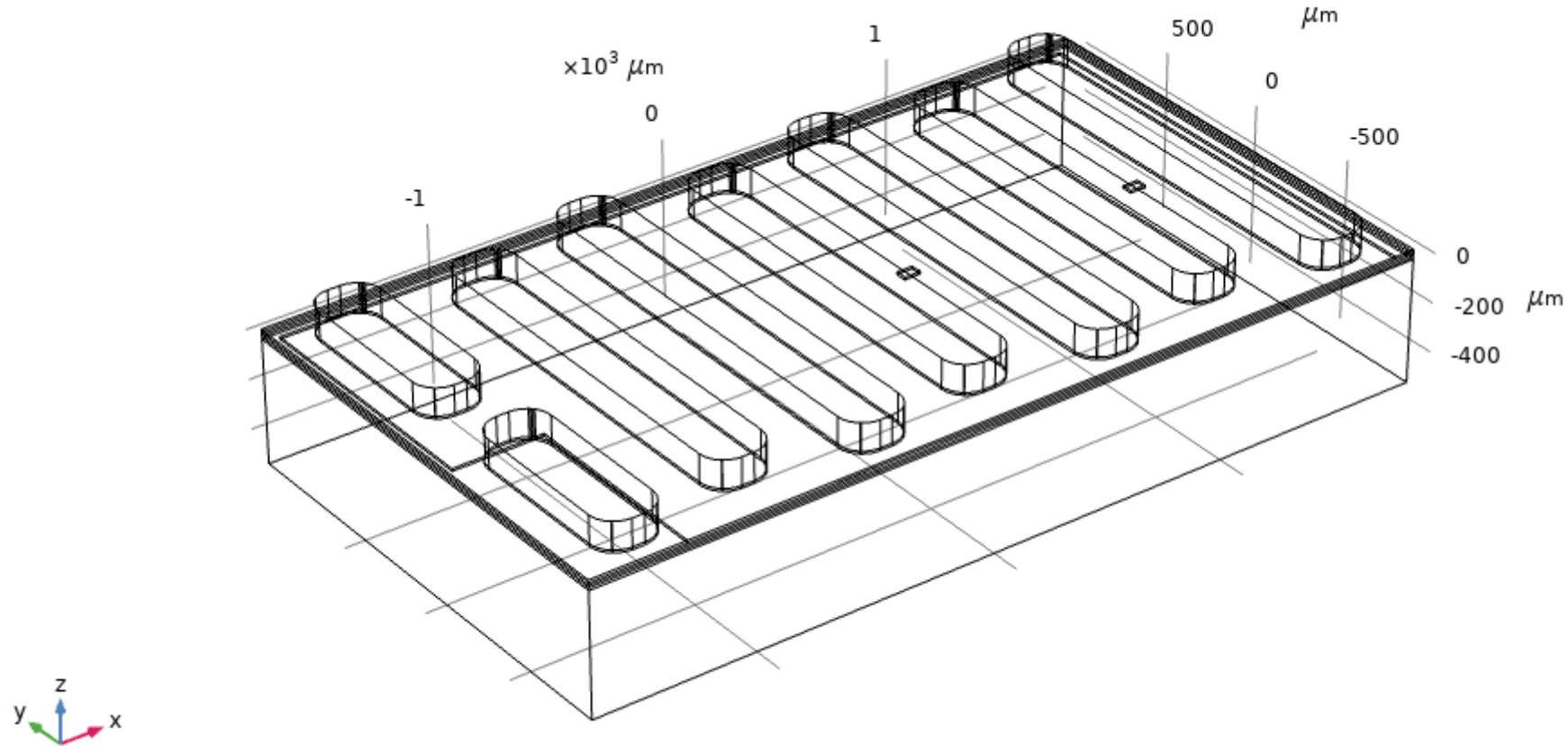

EPC2218 Steady-state $R_{\theta JB}$

Typical $R_{\theta JB} = 1.4 \text{ }^\circ\text{C/W}$

Volume: Temperature (K)

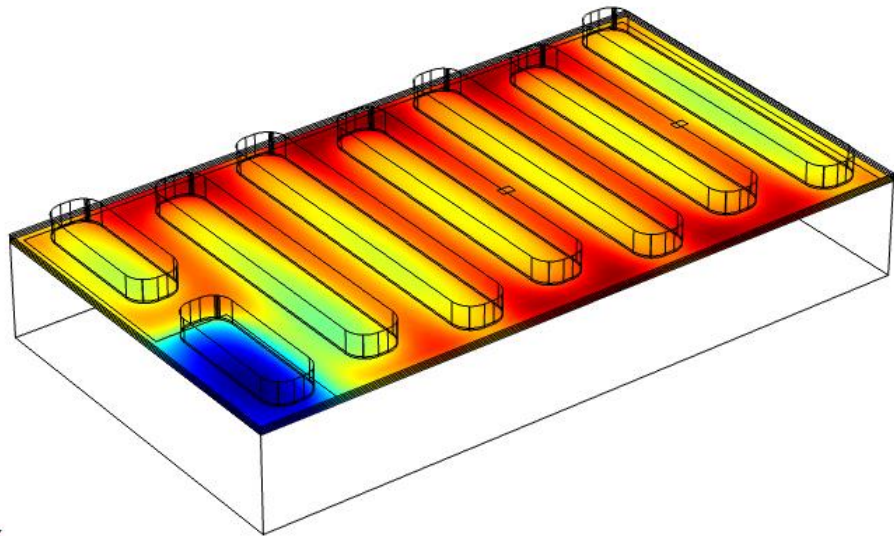

Volume: Temperature (K)

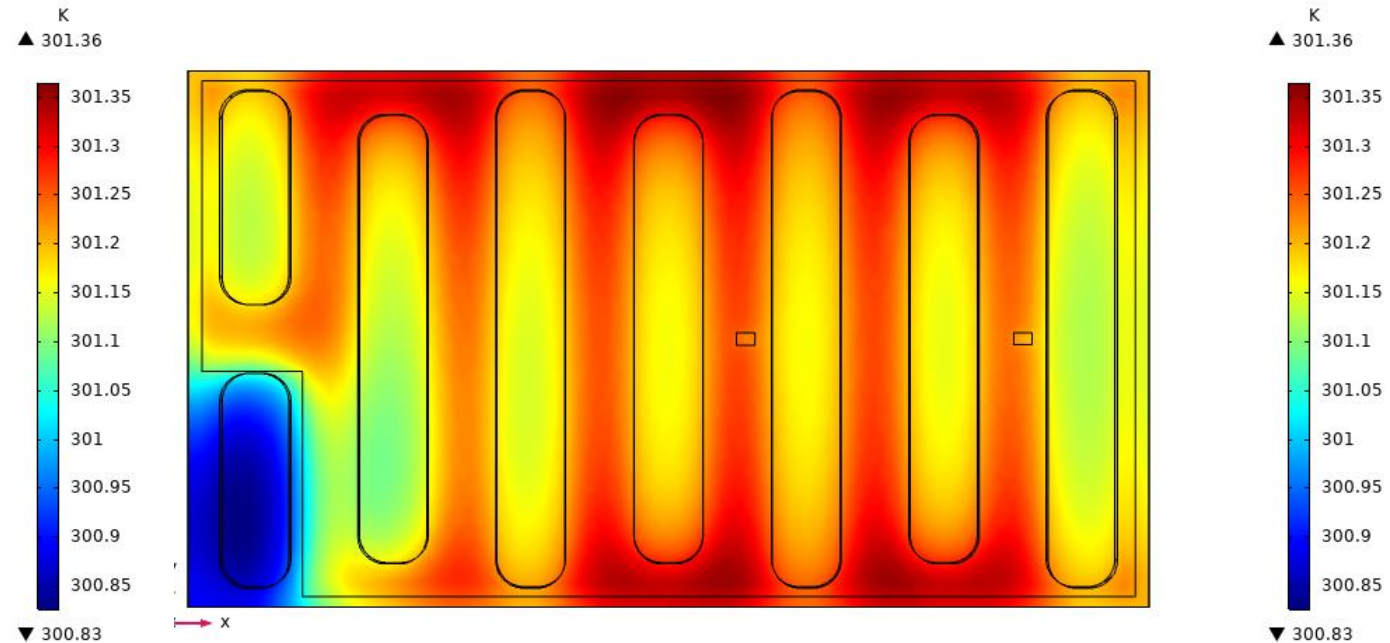

- Operating condition: Power = 1 W in the active area.
- Boundary condition: Temperature of top of solder bumps set to be 300 K.

EPC2218 Steady-state $R_{\theta JC}$

Typical $R_{\theta JC} = 0.5 \text{ } ^\circ\text{C/W}$

Volume: Temperature (K)

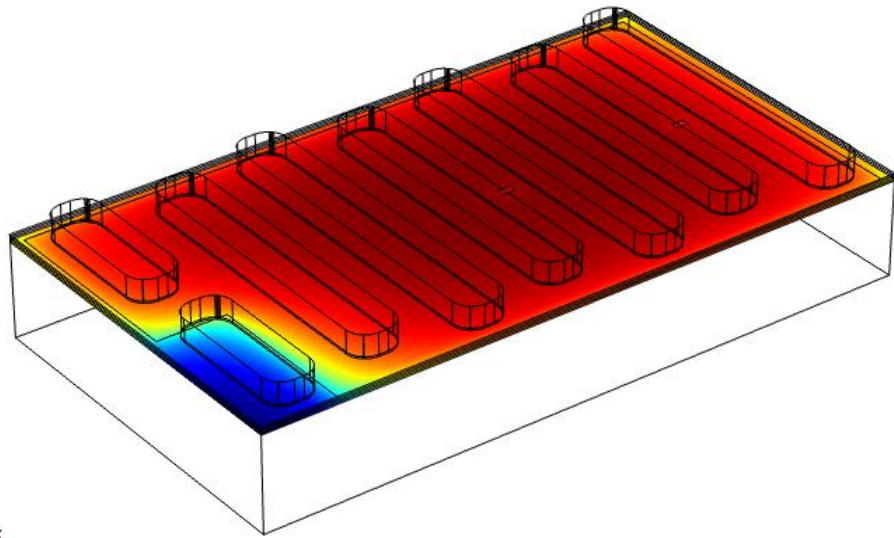

Volume: Temperature (K)

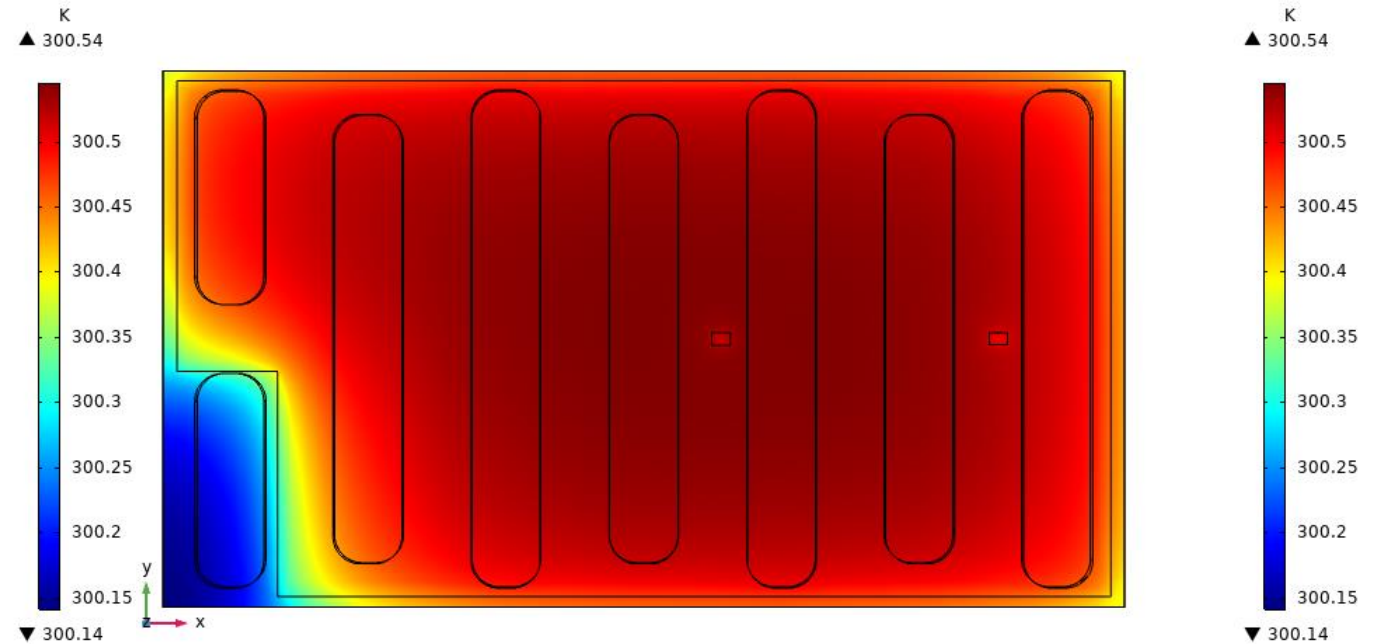

- Operating condition: Power = 1 W in the active area.
- Boundary condition: Temperature of the device backside set to be 300 K.

EPC2218 $Z_{\Theta JB}$ R-C thermal model

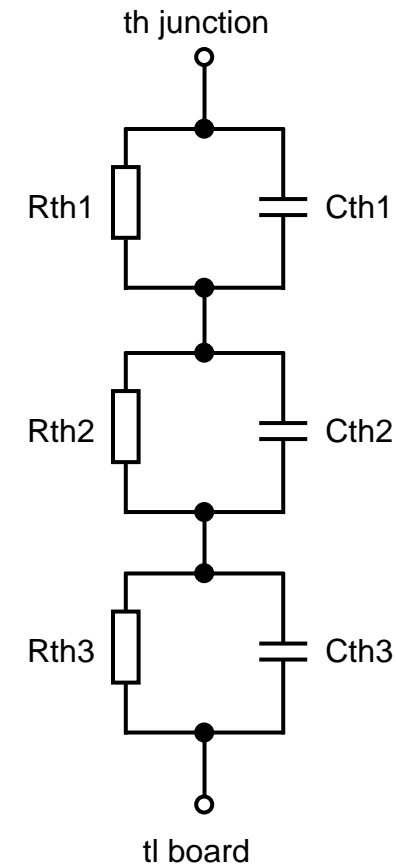
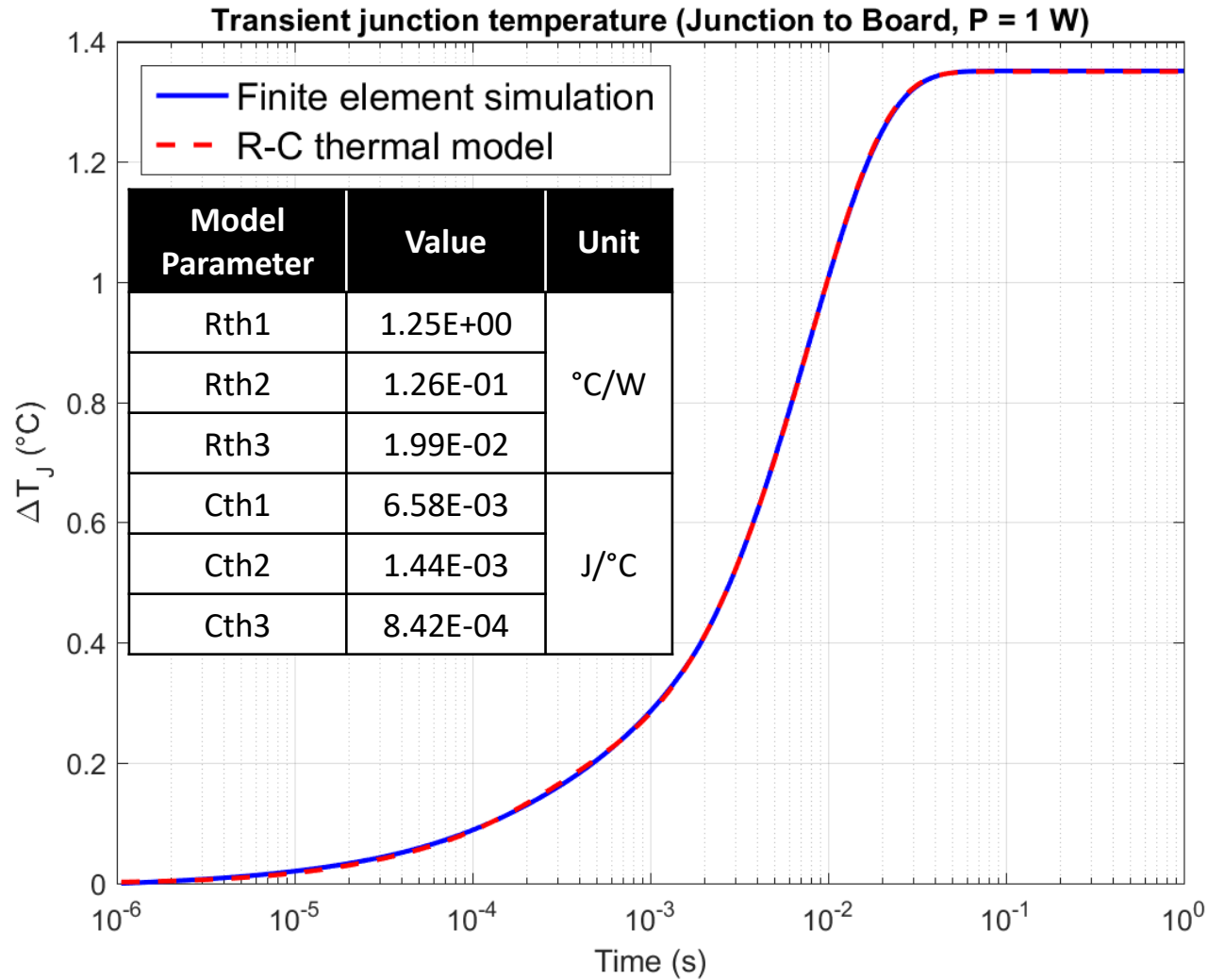

EPC2218 $Z_{\Theta JC}$ R-C thermal model

